















EVT8AGG EVTBBK

96" Sitting Height Conf. Table

P.1

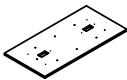

1  M8 Nut 16 PCS	2  Stand-off Ø20*76 2 PCS	3  Leveler 2 PCS	4  Wire Management Tray 870mm 1 PC	5  Grommet (Pre-assembly) 2 PCS	6  Screw M6*65mm 6 PCS
7  Screw M8*40mm 8 PCS	8  Screw M8*20mm 8 PCS	9  Screw M6*15mm 10 PCS	10  Wrench 4mm 1 PC	11  Wrench 5mm 1 PC	12  wrench(M8) 1 PC

A	B	C
 Top Panel 1 PC	 Leg 2 PCS	 Frame (1620mm) 2 PCS

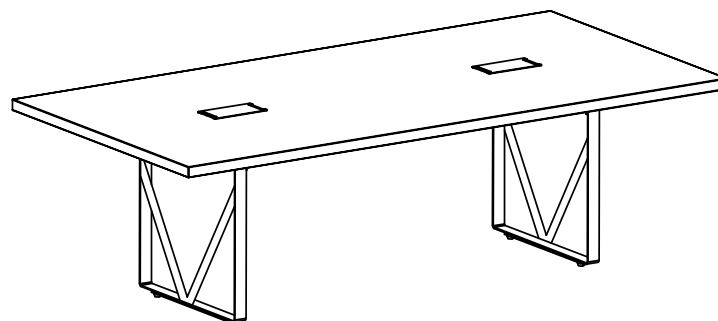

IMPORTANT NOTE:

- Place all wooden parts on a clean and smooth surface such as a rug or carpet to avoid the parts from being scratched
- Check that you have all parts and hardware.
- Remove all wrapping materials, including staples & packing straps before you start assemble.
- Do not tighten all screws or bolts until all completely assembled.
- Keep all hardware parts out of reach of children.

- 1** Use Screw (7、8) to connect Leg (B), Frame (C) together;

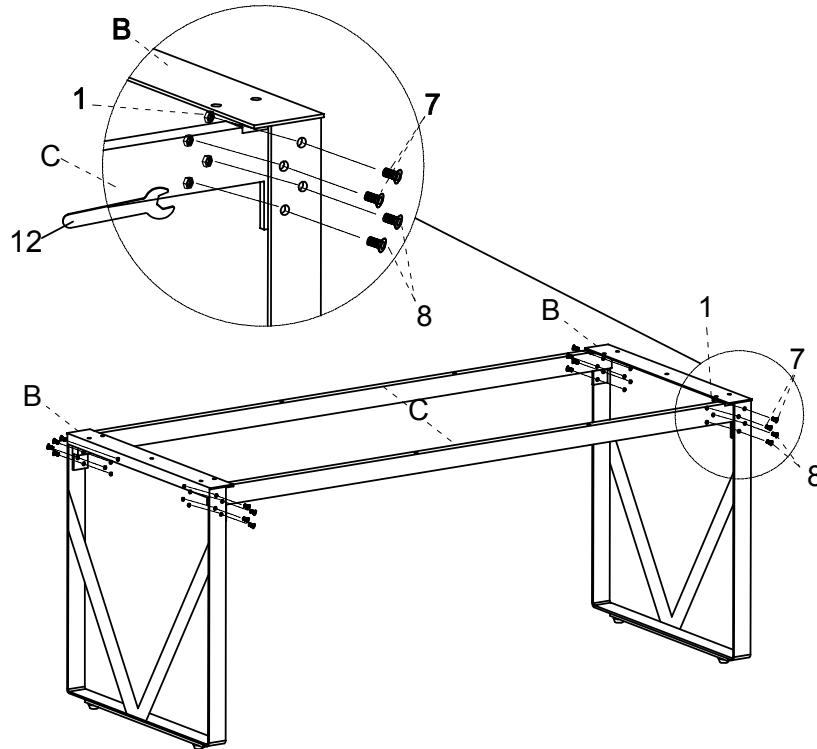

- 2** Install Stand-off (2) on Top Panel (A), Use the Leveler (3) to connect the Wire Management Tray (4) with the Stand-off (2); Use the screw (9) to connect the Leg (B) and Top (A).

